

EB*

1020*Tip*

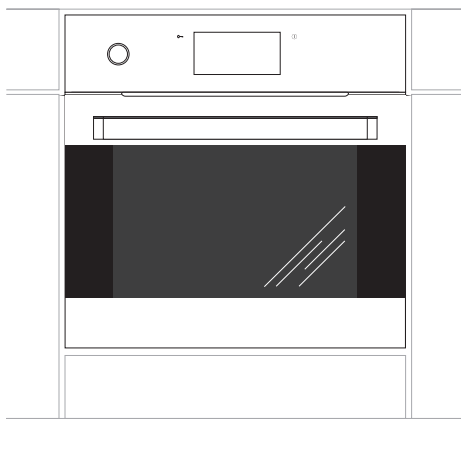

(EN) INSTRUCTION MANUAL

DEAR CUSTOMER,

The oven is exceptionally easy to use and extremely efficient. After reading the instruction manual, operating the oven will be easy.

Before being packaged and leaving the manufacturer, the oven was thoroughly checked with regard to safety and functionality.

Before using the appliance, please read the instruction manual carefully. By following these instructions carefully you will be able to avoid any problems in using the appliance.

It is important to keep the instruction manual and store it in a safe place so that it can be consulted at any time. It is necessary to follow the instructions in the manual carefully in order to avoid possible accidents.



Caution!

Do not use the oven until you have read this instruction manual.

The oven is intended for household use only.

The manufacturer reserves the right to introduce changes which do not affect the operation of the appliance.

TABLE OF CONTENTS

Safety instructions	4
Description of the appliance	8
Installation	10
Operation	13
Baking in the oven – practical hints	48
Cleaning and maintenance	50
Troubleshooting	55
Technical data	56

SAFETY INSTRUCTIONS

Warning: The appliance and its accessible parts become hot during use. Care should be taken to avoid touching heating elements. Children less than 8 years of age shall be kept away unless continuously supervised.

This appliance can be used by children aged from 8 years and above and persons with reduced physical, sensory or mental capabilities or lack of experience and knowledge if they have been given supervision or instruction concerning use of the appliance in a safe way and understand the hazards involved. Children shall not play with the appliance. Cleaning and user maintenance shall not be made by children without supervision.

During use the appliance becomes hot. Care should be taken to avoid touching heating elements inside the oven.

Accessible parts may become hot during use. Young children should be kept away.

Warning: Do not use harsh abrasive cleaners or sharp metal scrapers to clean the oven door glass since they can scratch the surface, which may result in shattering of the glass.

Warning: Ensure that the appliance is switched off before replacing the lamp to avoid the possibility of electric shock.

You should not use steam cleaning devices to clean the appliance.

Only use the meat probe recommended for this oven.

SAFETY INSTRUCTIONS

Danger of burns! Hot steam may escape when you open the oven door. Be careful when you open the oven door during or after cooking. Do NOT lean over the door when you open it. Please note that depending on the temperature the steam can be invisible.

- Ensure that small items of household equipment, including connection leads, do not touch the hot oven as the insulation material of this equipment is usually not resistant to high temperatures.
- Do not leave the oven unattended when frying. Oils and fats may catch fire due to overheating or boiling over.
- Do not put pans weighing over 15 kg on the opened door of the oven.
- Do not use harsh cleaning agents or sharp metal objects to clean the door as they can scratch the surface, which could then result in the glass cracking.
- Do not use the oven in the event of a technical fault. Any faults must be fixed by an appropriately qualified and authorised person.
- In the event of any incident caused by a technical fault, disconnect the power and report the fault to the service centre to be repaired.
- The rules and provisions contained in this instruction manual should be strictly observed. Do not allow anybody who is not familiar with the contents of this instruction manual to operate the oven.
- The appliance has been designed only for cooking. Any other use (for example for heating) does not comply with its operating profile and may cause danger.

HOW TO SAVE ENERGY



Using energy in a responsible way not only saves money but also helps the environment. So let's save energy! And this is how you can do it:

- **Do not uncover the pan too often (a watched pot never boils!).**

Do not open the oven door unnecessarily often.

- **Only use the oven when cooking larger dishes.**

Meat of up to 1 kg can be prepared more economically in a pan on the cooker hob.

- **Make use of residual heat from the oven.**

If the cooking time is greater than 40 minutes switch off the oven 10 minutes before the end time.

Important! When using the timer, set appropriately shorter cooking times according to the dish being prepared.

- **Make sure the oven door is properly closed.**

Heat can leak through spillages on the door seals. Clean up any spillages immediately.

- **Do not install the cooker in the direct vicinity of refrigerators/freezers.**

Otherwise energy consumption increases unnecessarily.

UNPACKING



During transportation, protective packaging was used to protect the appliance against any damage. After unpacking, please dispose of all elements of packaging in a way that will not cause damage to the environment.

All materials used for packaging the appliance are environmentally friendly; they are 100% recyclable and are marked with the appropriate symbol.

Caution! During unpacking, the packaging materials (polythene bags, polystyrene pieces, etc.) should be kept out of reach of children.

DISPOSAL OF THE APPLIANCE



Old appliances should not simply be disposed of with normal household waste, but should be delivered to a collection and recycling centre for electric and electronic equipment. A symbol shown on the product, the instruction manual or the packaging shows that it is suitable for recycling.

Materials used inside the appliance are recyclable and are labelled with information concerning this. By recycling materials or other parts from used devices you are making a significant contribution to the protection of our environment.

Information on appropriate disposal centres for used devices can be provided by your local authority.

DESCRIPTION OF THE APPLIANCE

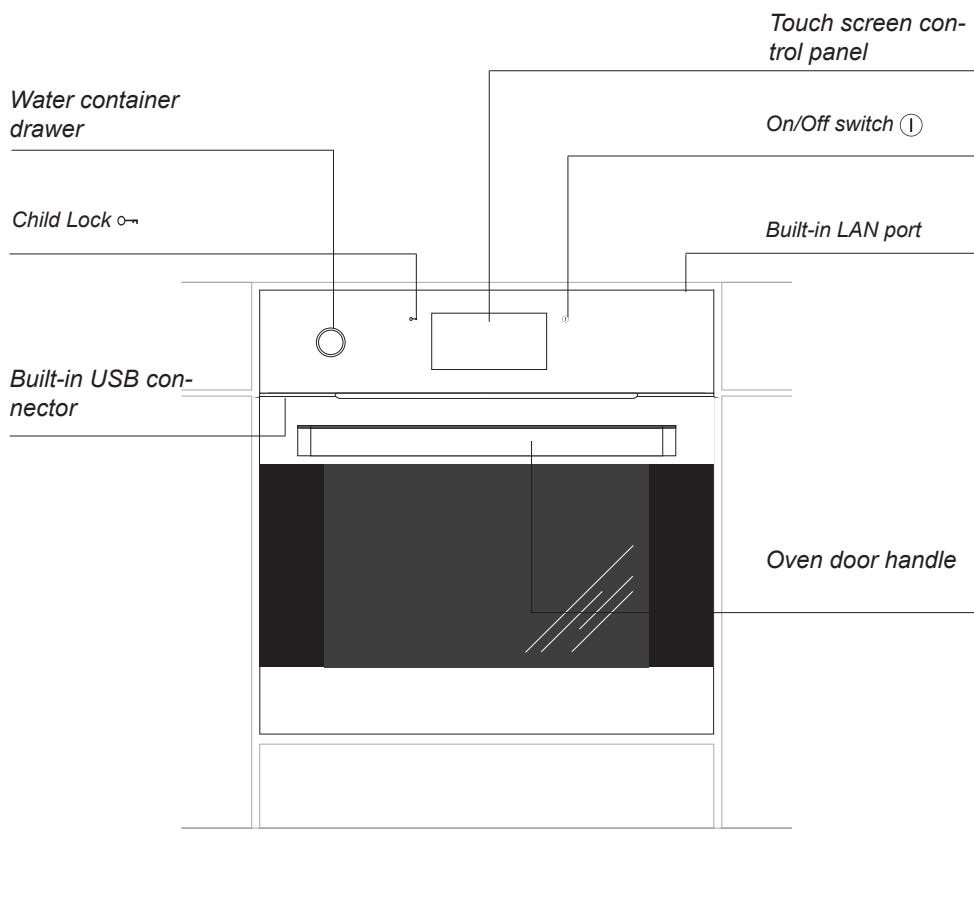

SPECIFICATIONS OF THE APPLIANCE

Cooker fittings:

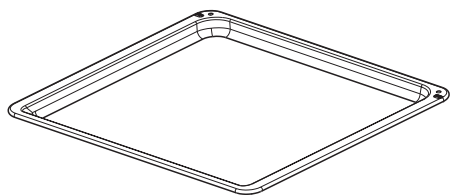

*Baking tray**

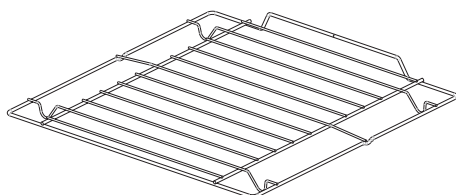

*Grill grate
(drying rack)*

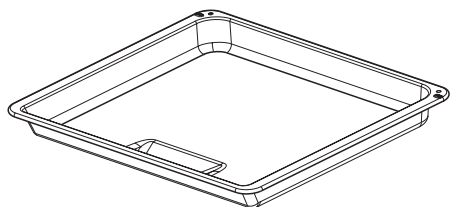

*Roasting tray**

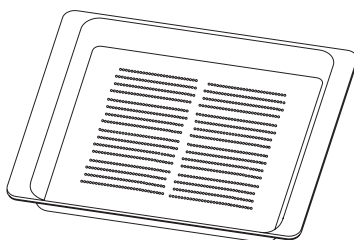

Perforated bowl

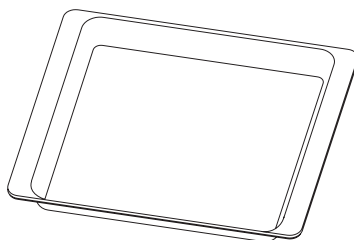

Solid bowl

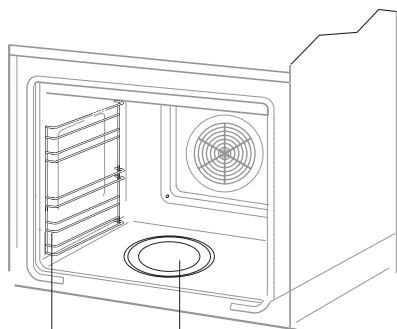

Wire shelf supports

Steam generator



Meat probe

*optional

INSTALLATION

Installing the oven

- The kitchen area should be dry and aired and equipped with efficient ventilation. When installing the oven, easy access to all control elements should be ensured.
- This is a Y-type design built-in oven, which means that its back wall and one side wall can be placed next to a high piece of furniture or a wall. Coating or veneer used on fitted furniture must be applied with a heat-resistant adhesive (100°C). This prevents surface deformation or detachment of the coating.
- Hoods should be installed according to the manufacturer's instructions.
- Make an opening with the dimensions given in the diagram for the oven to be fitted.
- Make sure the mains plug is disconnected and then connect the oven to the mains supply.
- Insert the oven completely into the opening without allowing the four screws in the places shown in the diagram to fall out.

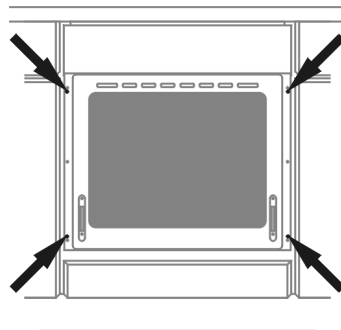
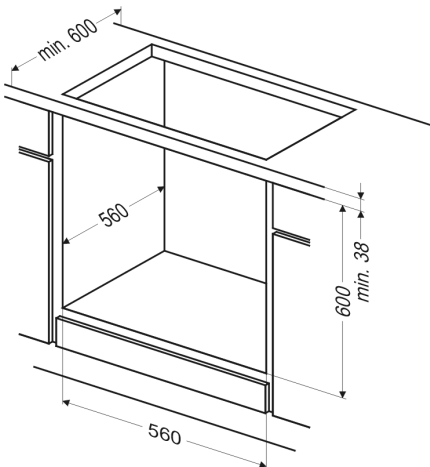
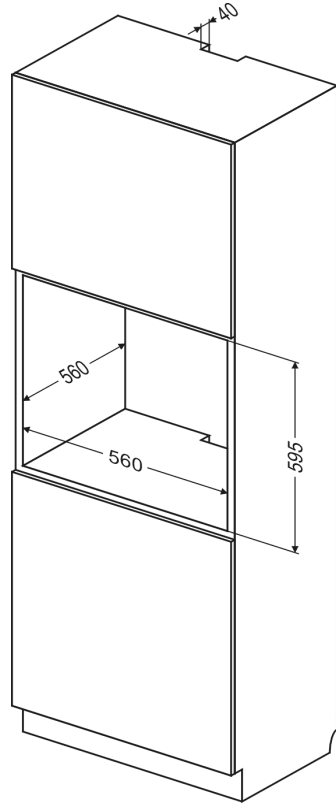

INSTALLATION

Adjust the position of the oven door

Adjustment mechanism allows you to change the height of right side of the oven door as limited by its design. Oven door height adjustment on one side allows you to level the door and align it with the control panel.

Adjustment method

- Loosen the nut [1] with size 13 open-end wrench.
- Use size 4 Allen key to rotate adjustment spindle [2] within 180° range to obtain the correct door position. The door position will be adjusted in the ± 1.5 mm range.
- Tighten the lock nut [1] while holding the adjustment spindle [2] in position using the Allen key.

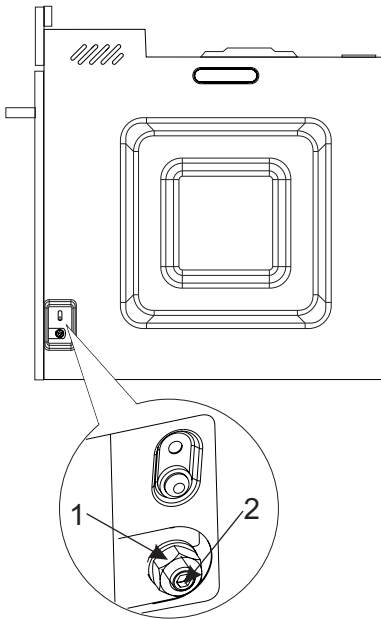

Electrical connection

- The oven is manufactured to work with a one-phase alternating current (230V 1N~50 Hz) and is equipped with a 3 x 1,5 mm² connection lead of 1.5 mm length with a plug including a protection contact.
- A connection socket for electricity supply should be equipped with a protection pin and may not be located above the cooker. After the cooker is positioned, it is necessary to make the connection socket accessible to the user.
- Before connecting the oven to the socket, check if:
 - the fuse and electricity supply are able to withstand the cooker load,
 - the electricity supply is equipped with an efficacious ground system which meets the requirements of current standards and provisions,
 - the plug is within easy reach.

Important!

If the fixed power supply cable is damaged, it should be replaced at the manufacturer or at an authorized servicing outlet, or by a qualified person to avoid danger.

INSTALLATION

Connect the oven to the Internet

To take advantage of the advanced oven features, connect it to the Internet.

This can be done in two ways:

- If you can reach the oven with an Ethernet cable terminated with RJ45 connector you can plug it directly into a LAN socket at the top of the oven body.

- If wireless Internet access is available, use the supplied wireless router. You need to first connect the router to your PC and connect it to an available wireless network (you will need the name of the local wireless network, its security mode and password). For guidance use Chapter 5 „Client Mode” in the router’s operating instructions.

After initial setup of your wireless router, you can connect it to the LAN port at the top of the oven body. Note — your router requires a separate power supply. Use a power adapter that came with your router.

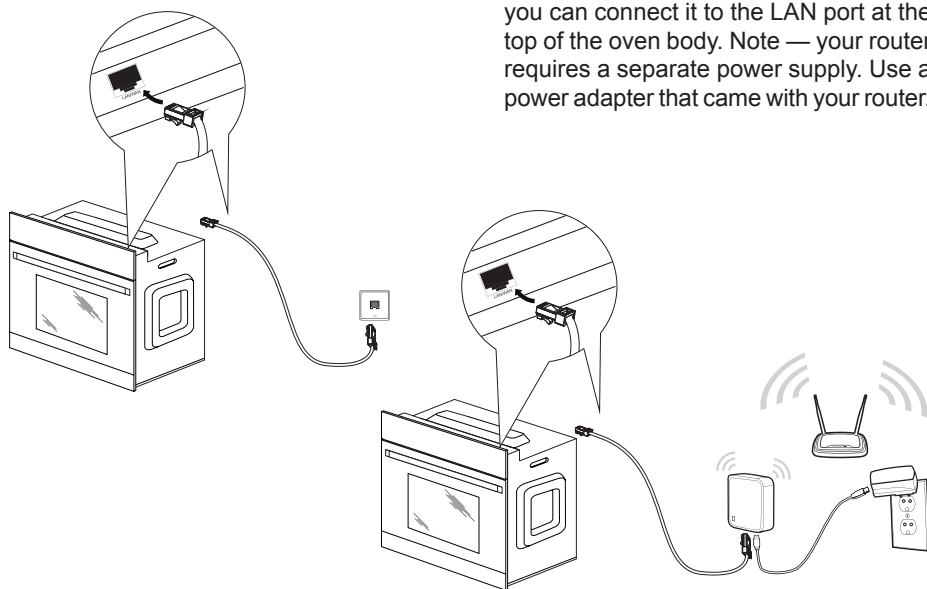

OPERATION

Before using the appliance for the first time

- Remove packaging, clean the interior of the oven,
- Take out and wash the oven accessories with warm water and a little washing-up liquid,
- Turn on the ventilation in the room or open a window,
- Heat up the oven (to a temperature of 250°C for approximately 30 minutes), remove any stains and wipe the interior carefully. (see section: **Using the control panel**),

Important!

To clean the oven chamber use only warm water and a small amount of washing-up liquid.

Important!

The oven is equipped with a touch screen display control panel. The control panel includes two touch sensors:

- ① On/off sensor
- ↔ Child Lock

To activate each touch sensor, touch the glass above the sensor (indicated by a pictogram). An acoustic signal will be heard, which was selected in the menu. (See section: *Using the control panel*),

Touch sensor surfaces must be kept clean.

There is a special application for PCs, tablets and smartphones that will help you use the appliance and update its firmware. Use the application to upload, modify and manage recipes, photo albums, weather settings, remote control settings and your home appliance network settings. Communication between the application and the oven can be performed via USB memory stick, a local area network (recommended, default) or world wide web (from anywhere).

The application setup files are included on the enclosed USB stick.

System Requirements:

Windows 7 or later, Windows Installer 4.5 of newer (for systems older than Windows 7, to be downloaded from <http://www.microsoft.com/pl-pl/download/details.aspx?id=8483>).

The installation must be performed with administrator rights (default for home users).

The app will be available for Android, iOS and OSX.

OPERATION

Using the control panel

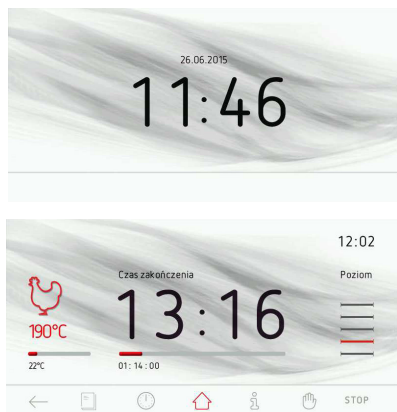

The notifications bar



The notifications bar shows the following information:

- child lock symbol,
- the remote control symbol,
- seven notification icons,
- The current time.

Notification icons are always displayed near the current time. If there are icons displayed on positions 2, 3, and 4, and during the appliance operation icon on position 3 disappears, then icon on position 2 will move to position 3.

The bottom widgets bar



- 1 **BACK** - touch to go back to the previous page/menu or up one level
- 2 **COOKBOOK** - touch to open the cook book,
- 3 **TIMER** - touch to set the timer,
- 4 **SHORTCUTS** - touch to display the default and user programmable shortcuts, as shown below,
- 5 - **INFORMATION** - touch to display appliance specs and information,
- 6 **FREEZE** - touch to freeze the touch screen display if you want to wipe it clean during the appliance operation
- 7 **OK/START** - touch to start/stop a function or confirm a setting.



Weather forecast

If you activate “Weather forecast in clock mode” (default), then current weather pictogram will be presented on the clock screen.

Use the PC/SF application to set the weather forecast location – the default is the capitol city of the region selected.

OPERATION

Drop-down widget menu

Touch the  symbol on the screen to expand the menu.



The bottom bar will show the “Back” and “Bluetooth.” symbols Default shortcuts shown in the top row: Heating Functions, Pre-set Programmes, User programmes, Update, Apps, Search, Device list. There are blank placeholders in the second row may be populated with new user-defined shortcuts, such as sub-menu, pre-set or user programme shortcuts. To edit, touch and hold an empty placeholder 3 seconds.

Touch the icon to open the corresponding menu.

You can choose one of the three sub-menus — Heating Functions, Pre-set programmes, User Programmes.

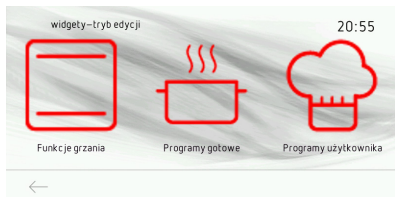

When you select the Poultry Pre-Set programme for a shortcut, touch the  symbol to save it.

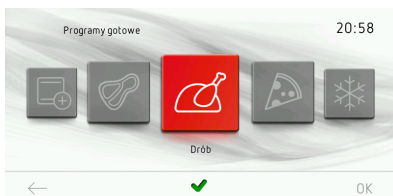

When you select the Grill Heating Function for a shortcut, touch the  symbol to save it.

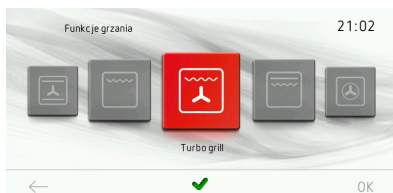

Once your choice is saved, the new shortcut populates the selected placeholder in the menu.



OPERATION

Firmware Update Widget.

When an Internet connection is detected, the appliance will attempt once a day to contact the update server and download the latest firmware version (if available). If an Internet connection is not available or there is no newer firmware version, the widget is displayed in grey. Touch it to go to the “firmware update” menu item.

If a firmware update is stored in appliance memory, the widget pictogram is red, and the arrow pointing at the widgets menu shows an envelope.

Touch the red widget pictogram and you will be asked to confirm you want to update your oven. Once confirmed, oven firmware will be updated.

App Widget.

When used for the first time the device running the app (PC, smartphone, tablet) automatically connects to the oven found on the same local network.

The app can connect to a maximum of 8 home appliances. Important — the app and the home appliance must be on the same local network.

Touch the widget pictogram to view the List of connected apps.

Search Widget

Use this feature to connect the oven to other home appliance such as a hob, cooker hood, or remotely controlled socket. In order to connect the oven to another home appliance you must first select connecting mode in the appliance and then touch the search widget pictogram.

The pictogram flashes when searching and turns green when a new appliance is found and connected or red the search fails.

Important — add appliance one by one.

The List of Appliances widget

Touch the widget pictogram to view the list of home appliance on the network. The status of a washing machine, dishwasher, cooker and the hood is displayed on the bottom bar, while above it there is a list of remotely controlled power sockets. Displayed for each socket is the measured voltage, current power consumption and the button to switch off the socket remotely. Each power socket may be given its own name (lamp, iron, toaster, PC). This can be done by using the application.

Standby

No information is displayed in standby mode. Power on touch sensor is clearly marked.

Touch on/off sensor to enter the operating mode.

There is a power saving mode option in the menu and it is turned on by default. Touch on/off to enter the standby mode. You can turn off this feature. Then when you touch on/off the oven turns off and shows clock/weather/slide show depending on other settings.

OPERATION

Select Language

After connecting the appliance to the mains, the user is prompted to select the menu language.

Select your preferred language from the rotating carousel display by swiping your finger left or right across the screen. Stop the carousel and touch the chosen country flag and touch OK to select the menu language.

After a power outage (or when the mains power is cut and restored), the appliance remembers the last language setting.

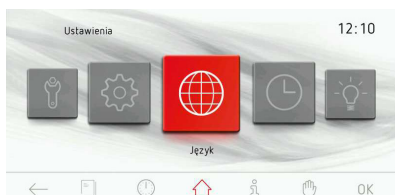

Set current time

Once your preferred language is set you now need to confirm the current time by touching OK or set the time using the slider or the +/- soft keys. Touch OK to confirm the current time.

Time can be set in the range from 0:00 to 23:59 for 24-hour clock system or from 0:00 to 12:00 for the 12-hour clock system.

When current time is set, the appliance displays the current time.

Touch  in standby to display current time. Touch the screen anywhere to activate the appliance and display the main menu. Rotate the carousel and select the Settings and then Time. Touch the icon on the front position directly or touch OK to confirm your selection.

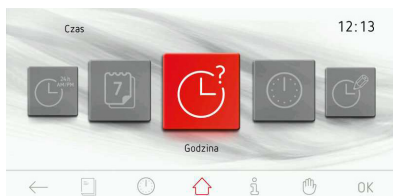

OPERATION

Set the current date

Stop the carousel and touch a menu item to enter the submenu. Another way to select the Settings menu item is to touch OK when the carousel has stopped.

When setting the date you first set the year (highlighted in black), then months and days. Touch +/- soft keys or use the slider bar to set the year. When the desired year is set, touch the month, at which point it becomes active, while the year and day are inactive. When the desired month is set, touch the day, at which point it becomes active, while the year and month are inactive. Touch OK to confirm the current date. When the date is set, the appliance displays current time.

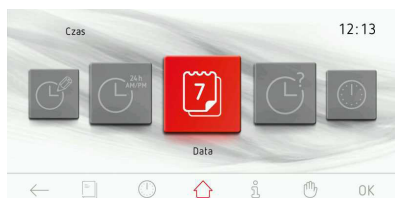

Main Menu

Touch  in standby to display current time. Touch the screen anywhere to activate the appliance and display the main menu.

Select the desired main menu item from the rotating carousel display by swiping your finger left or right across the screen. Stop the carousel and touch the chosen menu item to enter the submenu. Another way to select the main menu item is to touch OK when the carousel is stopped.

If you do not take any action within 60 seconds, the appliance will display the current time. Touch the BACK icon  to exit the Main Menu and display the current time.

The following main menu items are available:

- setup,
- heating functions,
- preset programmes,
- user programmes,
- cookbook,
- cleaning,
- slideshow.



OPERATION

Main Menu \ Settings

Stop the carousel and touch the Settings menu item to enter the submenu. Another way to select the Settings menu item is to touch OK when the carousel has stopped.

The following Settings menu items are available:

- language,
- time
- lighting,
- sound,
- themes,
- brightness,
- display brightness,
- weather forecast
- firmware update,
- service,
- special settings.

Swipe your finger across the screen to rotate the menu items. Stop the carousel and touch the chosen menu item to enter the submenu. Another way to select the chosen menu item is to touch OK when the carousel is stopped. If you do not take any action within 60 seconds, the appliance will display the current time. Touch the BACK icon ← to exit the Settings menu to the main menu and then display the current time.

Main Menu \ Settings \ Language

Stop the carousel and touch the Language menu item to enter the submenu. Another way to select the Settings menu item is to touch OK when the carousel has stopped.

The following language menu items are available:

- Deutsch,
- English,
- Polski,
- По русски,
- Český,
- Srpski,
- Lietuviškai,
- Eesti,
- Latviski,
- Français,
- Español,
- Türkçe,
- Svenska,
- Norsk,
- Suomi,
- Dansk,
- Italiano,
- Nederlands.

For details on how to select the menu language, please refer to the *Select language* section.

If you do not take any action within 60 seconds, the appliance will display the current time. Touch the BACK icon ← to exit from the Language menu to the Settings menu, the Main Menu and then display the current time.

Main Menu \ Settings \ Time

Stop the carousel and touch the Time menu item to enter the submenu. Another way to select the Settings menu item is to touch OK when the carousel has stopped.

The following Time menu items are available:

- date,
- current time,
- kitchen timer,

OPERATION

- clock type,
- time format.

Swipe your finger across the screen to rotate the menu items. Stop the carousel and touch the chosen menu item to enter the submenu. Another way to select the chosen menu item is to touch OK when the carousel is stopped. If you do not take any action within 60 seconds, the appliance will display the current time. Touch the BACK icon ← to exit from the Time menu to the Settings menu, the Main Menu and then display the current time.

Main Menu \ Settings \ Date

For details on how to set current date, please refer to the *Set the current date* section.

Main Menu \ Settings \ Time / current time

For details on how to set current time, please refer to the *Set the current time* section.

Setting Duration (for a heating function)

When you select any heating function the display will look as shown below (before setting the Duration or End time) - the screen is dimmed.

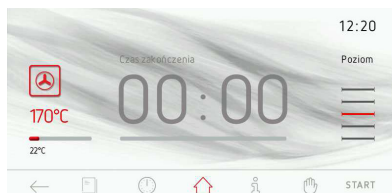

If you do not start the programme or modify the Duration setting within 60 seconds, the appliance will display the current time. Touch the BACK icon ← to exit the current screen. When you start the programme the START icon is replaced with the STOP icon.

Touch the screen within the box to set Duration. This will bring up the Duration screen, as shown below.

The →| symbol will flash in the top right corner.



If you do not set or accept Duration within 10 seconds, the selected heating function screen will be displayed. Touch ← to exit the Time setting screen at any time.

Touch +/- soft keys or use the slider bar to set the required Duration. Touch OK to confirm the Duration setting. The Duration setting screen will close. The →| icon will be shown in the upper corner on the notification

OPERATION

bar. The appliance will show time countdown and the animated red progress bar below End Time.



Once the Duration has elapsed, an acoustic signal is sounded (2 beeps / pause / 2 beeps) and the display backlight is flashing. The acoustic signal is repeated every 3 seconds. The →| icon is flashing as well. The maximum duration of an acoustic signal is 5 minutes.

Touch OK or any place on the screen to acknowledge and mute the acoustic signal. Afterwards the appliance will display the inactive Duration screen. If you do not start the programme again within 60 seconds, the appliance will display the current time.

Set Duration and End Time (for a heating function)

A) Set the Duration.

For more details on how to Set the Duration, please refer to the *Set the Duration (for the heating function)* section.

B) Set the End Time.

To set the End Time, Duration must be set on the Duration setting screen. The |→| symbol will be displayed.

Touch ⌚ to edit End Time. The |→| symbol will flash. If the user takes no action within 10 seconds, the selected heating function screen will be displayed with the previously set Duration

Touch ⌚ again while |→| is still flashing. You will now be able to set End Time. The |→| symbol stops flashing and the →| symbol starts to flash. If the user takes no action within 10 seconds, the selected heating function screen will be displayed with the previously set Duration

Touch +/- soft keys or use the slider bar to set the required End Time. Touch OK to confirm the End Time setting. The End Time setting screen will close. The Timer setting screen will be displayed. The →| and |→| symbols will be shown on the notification bar. The time remaining to start is shown on the animated progress bar.

This is shown on the on the animated progress bar below the time.

If the user takes no action within 60 seconds, the appliance will display the current time (the settings are retained). On the current time screen, the End Time →| and Duration |→| icons are shown on the notification bar. Both icons flash until the oven programme is started. When you touch the screen anywhere the appliance will display the last edited settings.

OPERATION

C) Appliance operation in selected mode

When the current time reaches the start time, the appliance will start the selected heating function. The display will show the Duration screen. When the programme is started the →| icon is extinguished and the |→| icon continues to be displayed. Once the Duration has elapsed, an acoustic signal is sounded and the display backlight is flashing. The |→| icon is flashing as well. The maximum duration of an acoustic signal is 5 minutes. Touch OK or any place on the screen to acknowledge and mute the acoustic signal. Afterwards the appliance will display the inactive Duration screen and the START button will be displayed.

If you do not start the programme again within 60 seconds, the appliance will display the current time.

Main Menu \ Settings \ Time \ Timer

Stop the carousel and touch the Timer menu item to enter the submenu. Another way to select the Timer menu item is to touch OK when the carousel has stopped.

This will bring up the Duration screen, as shown below.

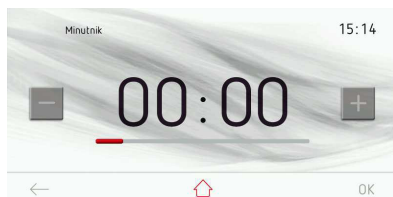

If you do not set or accept Duration within 10 seconds, the Timer screen will be displayed. Touch the BACK icon ← to exit the Timer menu.

Touch +/- soft keys or use the slider bar to set the required Duration. Touch OK to confirm the Duration setting. The Duration setting screen will close. The Timer setting screen will be displayed.

Touch OK to start the countdown of the preset Duration. If you do not start the countdown or modify the Duration setting within 60 seconds, the appliance will display the current time. Touch the BACK icon ← to exit the current screen. When the countdown is started the START button is replaced with the STOP button. The appliance will show time countdown and the animated red progress bar below End Time.

Once the Duration has elapsed, an acoustic signal is sounded and the display backlight is flashing. The maximum duration of an acoustic signal is 5 minutes.

OPERATION

Touch OK to acknowledge and mute the acoustic signal. Afterwards the appliance will display the Duration screen. If you do not set the Duration or does not restart the Timer within 5 seconds, the appliance will display the current time.

The kitchen timer is also available as an icon on the bottom bar.

Menu \ Setup \ Time \ Clock type

Stop the carousel and touch the Clock Type menu item to enter the submenu. Another way to select the Clock Type menu item is to touch OK when the carousel has stopped.

The following Clock Type menu items are available:

- standard,
- digital,
- analogue.

Touch the chosen Clock Type to select it. The selected Clock Type is highlighted in red. Touch OK to confirm your selection.

The selected clock will now appear in the upper right corner of the display and when current time is displayed.

If you do not take any action within 60 seconds, the appliance will display the current time. Touch the BACK icon ← to exit from the Clock Type menu to the Settings menu, the Main Menu and then display the current time.

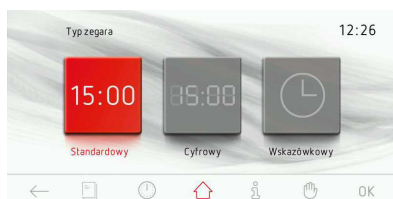

OPERATION

Main Menu \ Setup \ Time \ Time Format

Stop the carousel and touch the Time Format menu item to enter the submenu. Another way to select the Clock Type menu item is to touch OK when the carousel has stopped.

The following time format menu items are available:

- 24h,
- am/pm.

Touch the chosen Time Format to select it. The selected Time Format is highlighted in red. Touch OK to confirm your selection.

The time will now appear in the selected time format in the upper right corner of the display and when current time is displayed.

If you do not take any action within 60 seconds, the appliance will display the current time. Touch the BACK icon ← to exit from the Clock Type menu to the Settings menu, the Main Menu and then display the current time.



Menu \ Setup \ Lighting

Stop the carousel and touch the Lighting menu item to enter the submenu. Another way to select the Lighting menu item is to touch OK when the carousel has stopped. The following Lighting menu items are available:

- oven lighting,
- handle backlight.

Touch the chosen lighting to select it. The selected lighting is highlighted in red. Touch OK to confirm your selection.

If you do not take any action within 60 seconds, the appliance will display the current time. Touch the BACK icon ← to exit from the Lighting menu to the Settings menu, the Main Menu and then display the current time.

Access the oven lighting menu to select continuous or Eco mode.

Continuous Mode

When continuous lighting mode is selected, the light will be on continuously during the programme (heating function) or when the oven door is opened. When you open the oven door, the light will turn on for 10 minutes and then turn off. To turn on the light again you need to close and re-open the door.

Eco Mode

When ECO mode is selected, the light will be on for 30 seconds from starting a programme (heating function) and then the light is turned off. Touch the light symbol to turn the light back on during oven operation. Light will be turned off again after 30 seconds of touching the sensor field. When you open the oven door, the light will turn on for 10 minutes and then turn off. To turn on the light again you need to close and re-open the door.

OPERATION

Access handle backlight menu to select residual heat mode or decorative mode

Decorative mode

Activate the decorative mode to use the backlit oven door handle as a decorative element.

Residual heat mode

Oven door handle provides an additional residual heat indication — the handle lights up when the heating function is activated and it goes out when the oven has cooled down.

You can adjust handle brightness in the Settings \ Brightness menu.

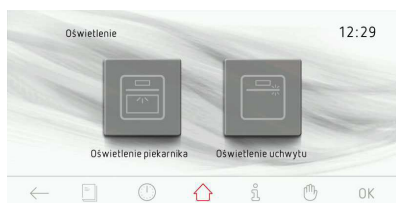

Main Menu \ Settings \ Sound

Stop the carousel and touch the Sound menu item to enter the submenu. Another way to select the Sounds menu item is to touch OK when the carousel has stopped. The following Sounds menu items are available:

- Menu sound,
- Programme end sound,
- Oven pre-heat end sound
- Volume.

Swipe your finger across the screen to rotate the menu items.

Touch the chosen Sound to select it. The selected Sound is highlighted in red. Touch OK to confirm your selection.

If you do not take any action within 60 seconds, the appliance will display the current time. Touch the BACK icon ← to exit from the Sounds menu to the Settings menu, the Main Menu and then display the current time.

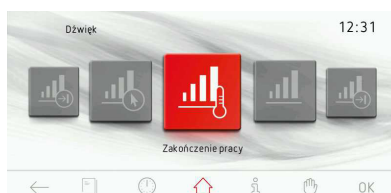

OPERATION

Main Menu \ Settings \ Sound \ Menu Sound

Stop the carousel and touch the Sounds menu item to enter the submenu. Another way to select a menu item is to touch OK when the carousel has stopped. The following Sounds menu items are available:

- Sound 1
- Sound 2
- Sound 3
- Sound 4
- Sound 5

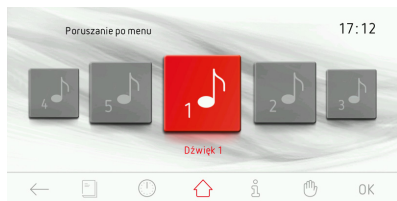

Swipe your finger across the screen to rotate the menu items.

Touch the chosen Sound to select it. The selected Sound is highlighted in red. Touch OK to confirm your selection.

If you do not take any action within 60 seconds, the appliance will display the current time. Touch the BACK icon ← to exit from the Sounds menu to the Settings menu, the Main Menu and then display the current time.

Main Menu \ Settings \ Sounds \ End Sound

Select the sound in the same way as described in the previous section.

Main Menu \ Settings \ Sounds \ Oven Pre-heat End Sound

Select the sound in the same way as described in the previous section.

Main Menu \ Settings \ Sound \ Volume

Stop the carousel and touch the Volume menu item to enter the Volume setting screen. Another way to select a menu item is to touch OK when the carousel has stopped. This will bring up the Volume screen.

If you do not set or accept the Volume within 10 seconds, the Volume menu screen will be displayed. Touch the BACK icon ← to exit the Volume setting screen.

Touch +/- soft keys or use the slider bar to set the required Volume. Touch OK to confirm the desired Volume setting.

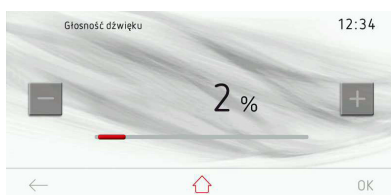

OPERATION

Main Menu \ Settings \ Themes

Stop the carousel and touch the Themes menu item to enter the submenu. Another way to select a menu item is to touch OK when the carousel has stopped. The following Themes menu items are available:

- Theme 1
- Theme 2
- Theme 3

Swipe your finger across the screen to rotate the menu items.

Touch the chosen Theme to select it. The selected Theme is highlighted in red. Touch OK to confirm your selection.

The selection is stored by the appliance and upper level menu is automatically displayed. The selected theme will now be applied to all screens.

If you do not take any action within 60 seconds, the appliance will display the current time. Touch the BACK icon ← to exit from the Themes menu to the Settings menu, the Main Menu and then display the current time.

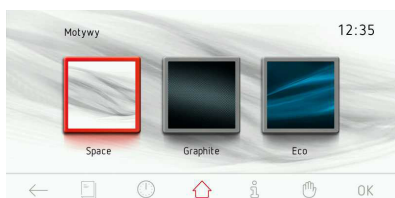

Main Menu \ Settings \ Brightness

Main Menu \ Settings \ Brightness
Stop the carousel and touch the Brightness menu item to enter the submenu. Another way to select a menu item is to touch OK when the carousel has stopped. There are two items in the Brightness menu — Display Brightness and Handle Brightness. Touch Display Brightness to enter a submenu:

- Clock mode display brightness
- Cook mode display brightness
- Slide show brightness

Touch the chosen menu item to select it. This will bring up the Brightness setting screen, as shown below.

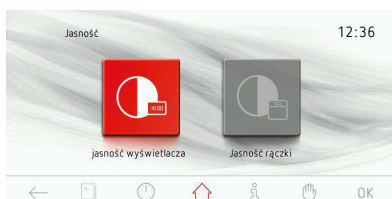

Touch +/- soft keys or use the slider bar to set the required Brightness. The brightness can be adjusted in the 0-100% range at 1% steps Touch OK to confirm the desired Brightness setting.

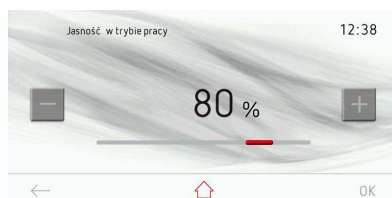

OPERATION

Main Menu \ Settings \ Weather

Stop the carousel and touch the Weather menu item to enter the submenu. Another way to select a menu item is to touch OK when the carousel has stopped. When you make your selection you will see the prompt “Display weather in clock mode?” YES/NO Touch YES to display weather forecast at the top right corner of clock screen. Touch OK to confirm your selection. Once confirmed weather forecast will be shown in clock mode. If you do not take any action within 60 seconds, the appliance will display the current time. Touch the BACK icon ← to exit from the Weather menu to the Settings menu, the Main Menu and then display the current time.



Main Menu \ Settings \ Firmware update

Stop the carousel and touch the Firmware update menu item to enter the submenu. Another way to select the Firmware update menu item is to touch OK when the carousel has stopped.

You can perform Firmware update using USB stick. In order to update firmware, follow the instructions presented on the oven screen and the firmware update application on your PC.

Note — to update oven firmware in this mode, you will need the USB stick provided with your oven and a PC connected to the Internet equipped with a USB port.

Note — firmware update by USB is an auxiliary procedure, it is recommended that you update directly via LAN.



OPERATION

Main Menu \ Settings \ Service

Stop the carousel and touch the Service menu item to enter the submenu. Another way to select a menu item is to touch OK when the carousel has stopped.

Possible error messages:

- No errors
- E0 - temperature sensor error
- E1 - meat probe sensor error
- E2 - steam generator sensor error

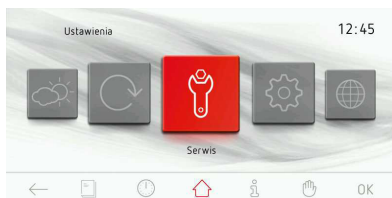

If the appliance detects an error, its code will be displayed as shown above.

If the E0 error is detected by the appliance, it is not possible to use the product and the Service Message screen is displayed continuously.

After the Service Message is displayed for 10 seconds, the appliance shows the current time. Touch OK or the BACK ← icon to exit the Service Message screen and display current time.

Any other use, such as navigating the menus or selecting any options or settings, is not possible. The Service Message screen is always displayed. Normal operation of the appliance will be restored once the fault is repaired.

If the E1 error is detected by the appliance, meat probe can't be used in any programme. If an attempt is made to select a programme where the meat probe is used, the appliance will display Service Message screen showing E1 error and its brief description. You can continue to use the appliance on the programs do not require the meat probe. Touch OK to acknowledge the Service Message screen and exit to main menu.

If no sensor is touched within 10 seconds when the E1 error Service Message screen is displayed, the appliance will automatically enter the standby mode. Normal operation of the appliance will be restored once the fault is repaired.

OPERATION

Main Menu \ Settings \ Special Settings

Stop the carousel and touch the Special Settings menu item to enter the submenu. Another way to select a menu item is to touch OK when the carousel has stopped.

The following Special Settings menu items are available:

- factory settings,
- Eco mode,
- Remote control.

Touch factory settings menu to restore the default factory settings. The selected symbol is highlighted in red. Touch OK to confirm your selection. The following settings will be restored.

Factory settings:

- Clock type: Flip Card
- time format: 24h,
- Lighting: Continuous
- Menu sound: Sound 1
- Programme end sound: Sound 1
- Oven Pre-heat End sound: Sound 1
- Volume: 20%
- Themes: Theme 1
- Clock brightness: 30%,
- Cook mode display brightness: 80%,
- Slide show brightness: 80%.

Select Eco menu to activate or deactivate the Eco mode. The selected symbol is highlighted in red. Touch OK to confirm your selection. After about 5 minutes of inactivity the appliance turns off.

Touch the Remote Control menu item to enable or disable remote control. The selected symbol is highlighted in red. Touch OK to confirm your selection.

When remote control is disabled, the oven will not communicate with the PC application over the internet. When remote control is enabled the \updownarrow symbol is displayed in clock and cooking mode. You are able to control the oven remotely.

When the oven is controlled remotely, the symbol is red. When remote control is enabled but not used, the symbol is grey. The symbol is not displayed when remote control is disabled.

You can remotely control your oven using the application provided on the enclosed USB stick.

Note. If ECO mode is enabled, you will not be able to wake the oven remotely. To wake the oven remotely, ECO mode must be disabled. Oven Control Panel has a higher priority than the remote control. If you turn on the oven using the Control Panel you will only be able to monitor oven functions and turn the appliance off remotely. It will be the same case when you turn on the oven remotely but then you use the Control Panel.

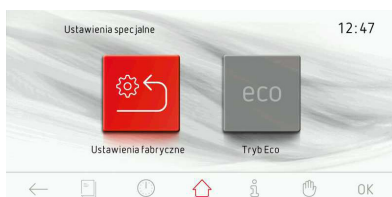

OPERATION

Main Menu \ Heating Functions

Stop the carousel and touch the Heating Functions menu item to enter the submenu. Another way to select a menu item is to touch OK when the carousel has stopped. The following heating functions menu items are available:

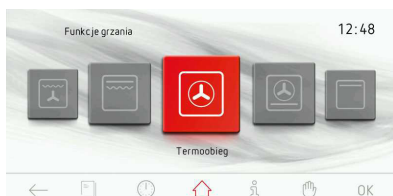

Overview of heating functions, possible temperature and default settings.

Pictogram	Heating function description	Default setting [°C]	Level from the bottom
	conventional	180	3
	cake	170	3
	grill	280	4
	turbo grill	200	2
	super grill	280	4
	fan with ring heating element	170	3
	fan with ring heating element ECO*	170	3
	pizza	220	2
	browning	180	-
	roasting	200	-
	defrosting	--	3

*ECO Fan Heater is an optimised heating function designed to save energy when preparing food.

OPERATION

Main Menu \ Heating Functions \ Fan cooking (Operation of any function using the example of fan cooking)

Touch ← at any time to end programme and exit to an upper menu level showing the available heating functions.

Stop the carousel and touch the fan cooking menu item to enter the submenu. Another way to select a menu item is to touch OK when the carousel has stopped. Appliance display will show the following information.

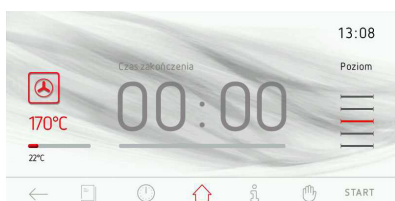

Touch START to start the programme. If you do not set Duration or Duration and Start Time within 10 seconds of starting a programme, the temperature and time indications are swapped and temperature is displayed in the middle of the screen. Appliance display will show the following information.



During a programme the fan heater operates periodically (thermostat) thus ensuring stability of the oven chamber temperature.

Touch STOP to end programme. The STOP soft key will be replaced with the START soft key. If you do not resume the programme within 60 seconds, the appliance will display the current time.

OPERATION

Using the meat probe

Plug in the meat probe into the socket and select a desired heating function.

Default meat probe temperature of 80°C is shown in temperature box on the display.

Touch START to start the programme. Cooling fan, light and grill heating element will be on.

Touch temperature or core temperature areas indicated by red boxes on the display to modify oven chamber temperature or core temperature. The appliance will show the temperature setting screen. If you do not set or accept a new temperature setting within 10 seconds, the selected heating function screen with all the settings will be displayed. Touch ← to exit the Temperature setting screen at any time.

Touch +/- soft keys or use the slider bar to set the required Temperature. Touch OK to confirm the Temperature setting. The Temperature setting screen will close. The upper level screen will be shown. The temperature bars show current temperatures: oven chamber and core temperature.

Touch STOP to end programme. The STOP soft key will be replaced with the START soft key. If you do not resume the programme within 60 seconds, the appliance will display the current time.

Touch ← at any time to end programme and exit to an upper menu level showing the available heating functions.

Once the core temperature reaches the set temperature, an acoustic signal is sounded and the display backlight is flashing. The display shows the set oven chamber temperature and core temperature and the  symbol is flashing. The maximum duration of an acoustic signal is 5 minutes.

Touch OK to acknowledge and mute the

acoustic signal. If you do not start the programme again within 60 seconds, the appliance will display the current time.

Opening the door during a programme disconnects the heating elements and convection fan motor (if used).

When not in use, disconnect the meat probe from its socket and remove from oven chamber.

Important!

Only use the meat probe recommended for this oven.

Recommended probe temperature settings

Type of meat	Temperature [°C]
Pork	85 - 90
Beef	80 - 85
Veal	75 - 80
Lamb	80 - 85
Venison	80 - 85

OPERATION

Main Menu \ Preset Programmes





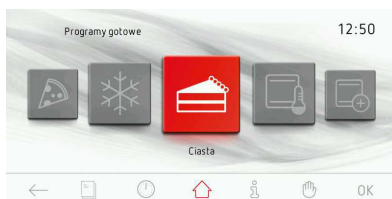



Stop the carousel and touch the Preset Programmes menu item to enter the submenu. Another way to select a menu item is to touch OK when the carousel has stopped.

The following Preset Programmes are available: meat, poultry, pizza, frozen products, pastry, steam cooking, low temperature baking, extra programmes.

















Pre-set programme	Dish	Preset settings		Level from the bottom
		Heating function	Temperature [°C]	
meat	pork		180	2
	beef		180	2
	veal		170	2
	lamb		180	2
poultry	chicken		190	2
	duck		180	2
	goose		170	2
	turkey		170	2
pizza	thin base		220	2
	thick base		200	2
	frozen		200	3
frozen products	fish		220	2
	Lasagne		200	2
	chips		200	3

OPERATION

pastries	crumble cake		175	2
	fruitcake		175	2
	cheesecake		160	2
	Swiss roll		200	2
	sponge cake		160	2
	muffins		160	3
	cookies		150	3
	bread		180	2
Steam programmes	sliced vegetables	Function 1	95	2
	frozen vegetables	Function 2	95	2
	broccoli, cauliflower	Function 3	90	2
	Asparagus	Function 4	95	2
	jacket potatoes	Function 4	95	2
	Vegetable casserole	Function 5	160	2
	Fish	Function 6	95	2
	Sea food	Function 7	95	2
	meat	Function 8	180	2
	Rice, couscous	Function 9	95	2
	Stewed apples	Function 10	95	2
	Stewed pears	Function 10	95	2
	Crème brûlée	Function 11	80	2
	bread	Function 12	180	2
	buns	Function 13	180	2
	reheating	Function 14	60	2

OPERATION

low temperature baking	rare fillet of beef		70	2
	medium rare fillet of beef		75	2
	beef roulade		80	2
	pork neck		90	2
	roast pork		90	2
	roast beef		80	2
	rare roast beef		70	2
	turkey breast		90	2
	pork loin		80	2
	veal		80	2
additional programmes	dough proving		30	2
	drying		50	2, 3, 4
	keep food warm		60	1
	heating plates		200	2
	pasteurization		130	1

OPERATION

Example: using a preset program with no oven preheating

Stop the carousel and touch the Poultry menu item to enter the submenu containing the relevant items: chicken, duck, goose, turkey. Touch the Chicken menu item to view the settings screen.

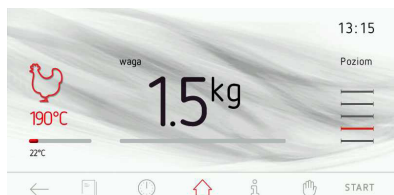

The default weight is displayed on the screen. Start the program if the default weight is correct.

Touch the weight setting area on the screen to modify the weight before starting a programme. The weight setting screen will be shown.



Touch the BACK icon ← to exit the Weight setting screen.

Touch +/- soft keys or use the slider bar to set the required Weight with 0.1 kg steps. Touch OK to confirm the desired Weight setting. The Weight setting screen will close. The upper level screen will be shown.

If you do not take any action within 60 seconds, the appliance will display the current time. Touch the BACK icon ← to exit from the Chicken menu to the Poultry menu, the Main Menu and then display the current time.

Touch START to start the programme. Cooling fan, light and fan, grill and spit motor will be on. Instead of weight, the remaining time to bake the chicken and an animated progress bar are shown on the screen.

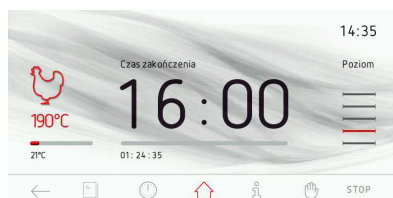

You can modify temperature settings for chamber oven or end time at any time, however, making any changes will modify the preset programme. Modifying temperature or time changes the chicken cooking programme into turbo grill programme and chicken symbol in the upper left corner of the display changes to turbo grill symbol.

Touch STOP to stop the programme at any time. If you do not take any action within 60 seconds of touching the STOP, the appliance will display the current time.

Once the duration proportional to the weight of chicken elapses ("List of preset programmes") an acoustic signal will be heard. The acoustic signal is repeated for about 5 minutes. The display shows the temperature

OPERATION

set for the oven chamber and END TIME, display backlight is flashing.

Touch OK or anywhere on the screen to acknowledge and mute the acoustic signal. After this, the appliance switches to standby mode.

Starting a steam programme

Stop the carousel and touch the Steam Programmes menu item to enter the sub-menu containing the relevant items: sliced vegetables, frozen vegetables, broccoli and cauliflower, asparagus, jacket potatoes, vegetable casserole, fish, seafood, meat, rice, couscous, stewed apples, crème brûlée, bread, rolls, reheating. Touch the selected menu item to open the settings screen. Another way to select a menu item is to touch OK when the carousel has stopped.

Note. Start steam cooking in a preheated oven.

To start steam cooking in the preheated oven, which has already been used to prepare another dish, first allow the temperature to drop to no more than 40°C.

This will ensure correct operation and ensure proper preparation of selected dishes.

The oven is equipped with special stainless steel bowls:

- perforated for vegetables and fish
- solid for meat.

Place bowls on the appropriate level in accordance with the displayed message.

Water container drawer is located in the front panel. Push and then pull the container (figure below). Pour 0.5 l of water into the container. Close the oven door.

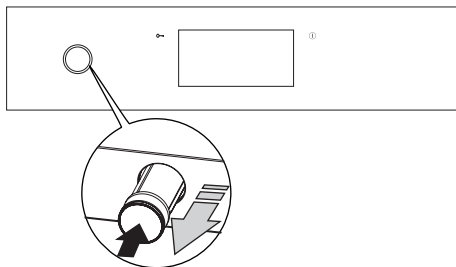

Touch START to start the programme. Cooling fan, light and fan heater and steam generator will be on.

Important. If you change the Duration (extend it) the steam generator may run out of water. Then the display will show a message "add water (0.5 l)". After adding the water, touch OK.

Countdown will stop automatically — programme will be resumed after a few seconds when added water in the generator is detected.

OPERATION

Menu / User Programmes



Stop the carousel on the User Programmes menu item and touch it to view a submenu of 20 user programmes that can be customized to your needs.

Another way to select the User Programmes menu item is to touch OK when the carousel has stopped.

Operating user programmes

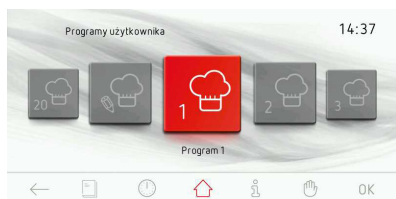
Stop the carousel on one of the 20 User Programmes and touch the selected programme to bring up the screen with default settings for all programmes. (Programmes 1 - 20 and editing screen): conventional cooking, temperature of 180°C, Duration 00:30 minutes.



The display shows the set oven temperature, END TIME and   symbol and display backlight is flashing.

Touch OK to acknowledge and mute the acoustic signal. After this, the appliance switches to standby mode.

You can modify the temperature or time during the programme. If you change the default time or temperature, the name "Programme 1" (or user-customised name) will change to the heating function name associated with a given programme. The Chef's Hat symbol changes to the programmed heating function symbol.



If you do not start the programme or modify the Duration or temperature within 60 seconds, the appliance will display the current time. Touch the BACK icon  to exit the current screen. When you start the programme the START icon is replaced with the STOP icon.

Touch START to start the programme. Cooling fan, light and top and bottom heating elements will be on. In the duration box of the preset programme, DURATION changes to END TIME and consequently Duration of 0:30 is replaced with End Time and the remaining time is shown on the progress bar.

Once the Duration has elapsed, an acoustic signal is sounded. The acoustic signal is repeated for about 5 minutes.

OPERATION

Editing user programme settings

When in the User Programmes submenu, stop the carousel on the "EDIT" menu item (item 21 — first item to the left of Programme 1) and touch it to enter a submenu of 20 editable programmes. This will be indicated by the "edit mode" title at the top of the screen.



Item being edited is highlighted. Touch heating function symbol to display carousel of available heating functions. Touch the desired heating function symbol and confirm your choice. You will return to "edit mode". On-screen keyboard is displayed to enter the programme name. Enter the new name and touch OK to confirm. Touch ← to exit the name editing screen at any time.



"Edit mode" screen is shown once the new name is entered and confirmed.

Temperature box is highlighted. Touch the temperature box to view the temperature setting screen. Set the desired temperature and touch OK to confirm.

Duration box is highlighted. Touch Duration box to view the Duration setting screen. Set the desired Duration and touch OK to confirm.

The Oven level box is highlighted.

Touch Oven level box [5] to view the Oven level setting screen. Touch +/- soft keys to set the desired Oven level. Set the desired Oven level and touch OK to confirm.

The upper level screen is displayed, the progress bar is ready and the message "editing complete" is displayed for 2 seconds.

When the message "editing complete" is displayed for 2 seconds, the User Programmes carousel is shown.

OPERATION

Main menu / Cookbook

Stop the carousel and touch the Cookbook menu item to view a submenu with the following items: Pastries, Meat, Poultry, Italian Dishes, Cakes, Fish, Vegetarian Dishes, Regional Dishes, Update Cookbook. Another way to select the Cookbook menu item is to touch OK when the carousel has stopped.



If you do not take any action within 60 seconds, the appliance will display the current time. Touch the BACK icon ← to exit the Cookbook screen.

Example: Touch Italian Dishes, then Pizza to view a list of available recipes.

Select the desired recipe from the list and touch it to view the recipe. Touch the "up" or "down" arrow to scroll through the list of recipes.



Cookbook — QR code.

When you view a recipe, the cookbook widget icon changes to a QR code. Touch the QR code symbol to maximise the QR on the screen. Scan the QR code to view the list of ingredients on your mobile device. Touch the QR code icon again to view the recipe again.



Main Menu / Cookbook / Update Cookbook

Stop the carousel and touch the Update Cookbook menu item to enter the submenu. Another way to select a menu item is to touch OK.



If you do not plug in a USB flash drive into the oven USB socket within 2 minutes, the appliance will display the current time. Touch the BACK icon ← to exit the Firmware Update screen.

Proceed the same as for the Firmware Update.

OPERATION

Main Menu / Cleaning

Stop the carousel and touch the Cleaning menu item to enter the submenu. Another way to select the menu item is to touch OK when the carousel has stopped.

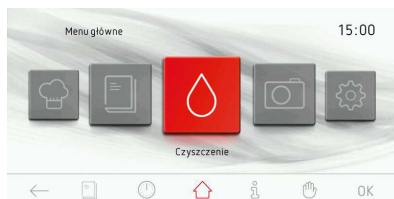

acoustic signal. After this, the appliance switches to standby mode.

The Cleaning Settings are as follows: the heating function — bottom heater, temperature 90°C.

If you do not start the programme again by touching START within 60 seconds, the appliance will display the current time. Touch the BACK icon ← to exit the current screen.

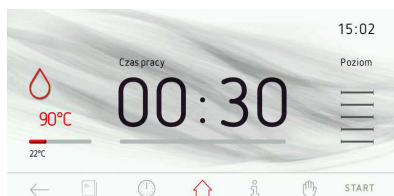

Pour about 500 ml of water onto the bottom of the oven chamber, close the door and touch START to start the programme. When you start the programme the START icon is replaced with the STOP icon.

Once the Duration has elapsed, an acoustic signal is sounded. The acoustic signal is repeated for about 5 minutes.

The display shows the set oven temperature, END TIME and |→| symbol and display backlight is flashing.

Touch OK to acknowledge and mute the

OPERATION

Main menu / Slide show

Stop the carousel and touch the Slideshow menu item to view a submenu with the following items: Select Photo Album, Transitions, Slide Show Speed, Start Slide Show, Update photos.

Touch the chosen menu item to select it and it will be highlighted in red. Touch OK to confirm your selection.

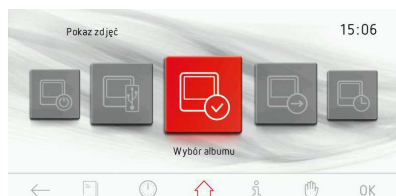

If you do not take any action within 60 seconds, the appliance will display the current time. Touch the BACK icon ← to exit the Slide Show screen.

Main Menu / Slideshow / Select Photo Album

Stop the carousel and touch the Select Photo Album menu item to view a submenu with the following items: Album 1... Album 5. Touch one of the photo albums and the selected photo album thumbnails will be shown.

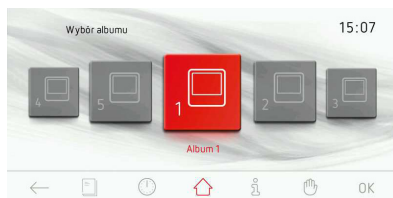

Swipe your finger across the screen to scroll through each page (1-17) of thumbnails. Touch on hold a thumbnail for 1 second to view the photo. The photo will be displayed on full screen. Touch the BACK ← icon in the bottom left corner to go back to the thumbnails screen. Touch anywhere on the screen to go back.

Touch OK in the thumbnails view to select the photo album.

OPERATION

Main Menu / Slideshow / Slideshow order

Stop the carousel and touch the Slideshow order menu item to view the slideshow viewing order submenu. Touch the desired slideshow viewing order. The selected slideshow viewing order is highlighted in red. Touch OK to confirm your selection.



If you do not take any action within 60 seconds, the appliance will display the current time. Touch the BACK icon ← to exit from the Slideshow viewing order menu to the Slideshow menu, the Main Menu and then display the current time.

Main Menu / Slideshow / Slideshow speed

Stop the carousel and touch the Slideshow speed menu item to view the slideshow speed submenu. Another way to select the Slideshow speed menu item is to touch OK when the carousel has stopped. This will bring up the setting screen, as shown below.



If you do not set or accept the Slideshow speed within 60 seconds, the upper level Slideshow menu screen will be displayed. Touch the BACK icon ← to exit from the Slideshow speed menu to the Slideshow menu, the Main Menu and then display the current time.

Touch +/- soft keys or use the slider bar to set the required Slideshow speed. Touch OK to confirm the desired Slideshow speed setting. The Slideshow speed setting screen will close. The upper level screen will be shown.

OPERATION

Main Menu / Slideshow / Run Slideshow

Stop the carousel and touch the Run Slideshow menu item to view the submenu. Touch the selected item. The selected slideshow viewing order is highlighted in red. Touch OK to confirm your selection.



If you do not take any action within 60 seconds, the appliance will display the current time. Touch the BACK icon ← to exit from the Run Slideshow menu to the Slideshow menu, the Main Menu and then display the current time.

Main menu / Slideshow / Update Photos

Stop the carousel and touch the Update Photos menu item to enter the submenu. Another way to select the Update Photos menu item is to touch OK when the carousel has stopped.



If you do not plug in a USB flash drive into the oven USB socket within 2 minutes and touch OK, the appliance will display the current time. Touch the BACK icon ← to exit the current screen. Proceed the same as for the Firmware Update.

Information

Touch ⓘ to view the appliance specifications. Touch the BACK icon ← to exit the current screen.

OPERATION

Cooling fan operation

Cooling fan is started whenever oven chamber temperature exceeds 50°C regardless of any heating function operating or not.

Once cooking is finished the display shows current time and oven chamber temperature bar.

Lighting

According to an option selected in **Menu / Setup / Lighting**, light is switched on when any heating function is in operation.

Regardless of the option selected in **Menu / Setup / Lighting**, light illuminates continuously for 10 minutes when oven chamber door is opened and turns off when the door is closed.

Opening the door during a programme disconnects the heating elements and convection fan motor (if used). Normal operation is resumed after that door is closed.

ECO feature

Eco function allows the use of residual heat in the oven chamber to heat food.

Eco function is available for the following heating functions:



The Eco function involves disconnecting the heater 5 minutes before Duration elapses.



ECO feature can be used when a Duration of a minimum of 10 minutes is set.



OPERATION

Special functions



Child Lock

How to activate?

Touch and hold  for 3 seconds to activate the Child Lock. Activation of Child Lock is indicated on the display by  symbol and a short beep.

When the Child Lock is enabled it is not possible to make any changes to the cooking programmes. Only the Child Lock and On/Off touch sensors are active. When Child Lock is active use  touch sensor to terminate a programme and show current time. If you touch the screen when the Child Lock is active, one long beep will be heard and the following message will be displayed: "Touch and hold  for 3 seconds to unlock."

How to deactivate?

Touch and hold  for 3 seconds to deactivate the Child Lock. The symbol  will disappear and a short beep will be heard.

Automatic power cut-off

If the oven operates any heating function for a long (excessive) period of time, heating elements are disconnected.

Example: If oven cavity temperature is 200°C heater are turned off after about 3 hours. At a temperature of 100°C after about 10 hours. This prevent overheating.

If all the heating elements are disconnected, this is indicated by a flashing display backlight and the  symbol.

Touch and hold  for 2 seconds to deactivate the automatic power cut-off. After this, the appliance shows current time.

BAKING IN THE OVEN – PRACTICAL HINTS

Baking

- we recommend using the baking trays which were provided with your cooker;
- it is also possible to bake in cake tins and trays bought elsewhere which should be put on the drying rack; for baking it is better to use black trays which conduct heat better and shorten the baking time;
- shapes and trays with bright or shiny surfaces are not recommended when using the conventional heating method (top and bottom heaters), use of such tins can result in undercooking the base of cakes;
- when using the ultra-fan function it is not necessary to initially heat up the oven chamber, for other types of heating you should warm up the oven chamber before the cake is inserted;
- before the cake is taken out of the oven, check if it is ready using a wooden stick (if the cake is ready the stick should come out dry and clean after being inserted into the cake);
- after switching off the oven it is advisable to leave the cake inside for about 5 min.;
- temperatures for baking with the ultra-fan function are usually around 20 – 30 degrees lower than in normal baking (using top and bottom heaters);
- the baking parameters given in Table are approximate and can be corrected based on your own experience and cooking preferences;
- if information given in recipe books is significantly different from the values included in this instruction manual, please apply the instructions from the manual.

Roasting meat













- cook meat weighing over 1 kg in the oven, but smaller pieces should be cooked on the gas burners.
- use heatproof ovenware for roasting, with handles that are also resistant to high temperatures;
- when roasting on the drying rack or the grate we recommend that you place a baking tray with a small amount of water on the lowest level of the oven;
- it is advisable to turn the meat over at least once during the roasting time and during roasting you should also baste the meat with its juices or with hot salty water – do not pour cold water over the meat.

BAKING IN THE OVEN – PRACTICAL HINTS

ECO Fan Heater

- ECO Fan Heater is an optimised heating function designed to save energy when preparing food.
- You cannot reduce the cooking time by setting a higher temperature; preheating the oven is not recommended.
- Do not change the temperature setting and do not open the oven door during cooking.

Recommended setting for ECO Fan Heater

Type of dish	Oven functions	Temperature °C	Level (4)	Time in minutes
	 ECO	180 - 200	2 - 3	50 - 70
	 ECO	180 - 200	2	50 - 70
	 ECO	190 - 210	2 - 3	45 - 60
	 ECO	200 - 220	2	90 - 120
	 ECO	200 - 220	2	90 - 160
	 ECO	180 - 200	2	80 - 100

CLEANING AND MAINTENANCE

Proper routine maintenance and cleaning of the oven can significantly extend its trouble-free operation.



Turn off the oven before cleaning. Do not begin cleaning until the oven has cooled.

- Clean the oven after each use. When cleaning the oven turn on lights to improve visibility of the interior.
- To clean the oven chamber use only warm water and a small amount of washing-up liquid.

- **Cleaning**

Proceed as described in the section *Menu / Cleaning*.

When the steam cleaning process is completed, wipe out the chamber with a damp cloth or a sponge soaked in a mild solution of washing-up liquid.

- After cleaning wipe over chamber dry.
- Use a soft, moisture absorbing cloth to clean surfaces.

Note. After each use wipe the steam generator dry with a sponge to collect water. Any remnants of the scale are best removed with water and vinegar.

Important!

Do not use any abrasive agents, harsh detergents or abrasive objects for cleaning.

Only use warm water with a small amount of dishwashing liquid to clean the front of the appliance. Do not use washing powders or creams.

CLEANING AND MAINTENANCE

- Ovens marked with the letter **D** are equipped with easily removable wire shelf supports. To remove them for cleaning use size 3 Allen key to undo the Z1 and Z2 fixing screws from shelf support holders. Once cleaned, replace the shelf supports in oven chamber. Before tightening, make sure the shelf support holders are secure in the holes provided in oven chamber wall.

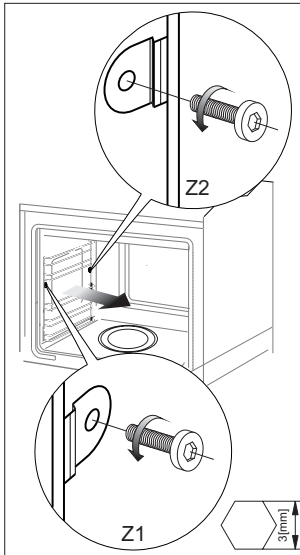

Removing wire shelf supports

- Ovens marked with the letters **Dc** have stainless steel sliding telescopic runners attached to the wire shelf supports. The telescopic runners should be removed and cleaned together with the wire shelf supports. Before you put the baking tray on them, they should be pulled out (if the oven is hot, pull out the telescopic runners by hooking the rear edge of the baking tray at the front of the telescopic runners) and then slide along with the tray.

Important!

Do not wash telescopic runners in a dishwasher.

Removing telescopic runners

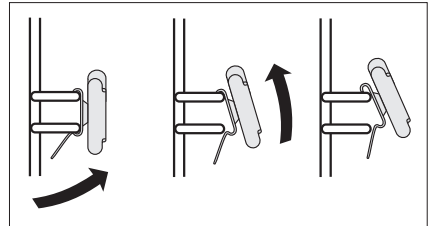

Installing telescopic runners

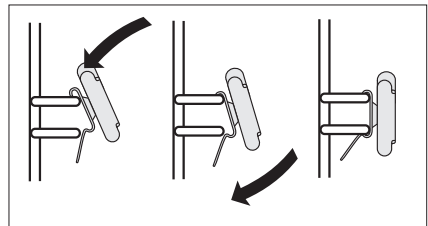

CLEANING AND MAINTENANCE

Replacing the halogen bulb in the oven

Before replacing the halogen bulb, make sure the appliance is disconnected from the electric mains to avoid a possible electric shock.

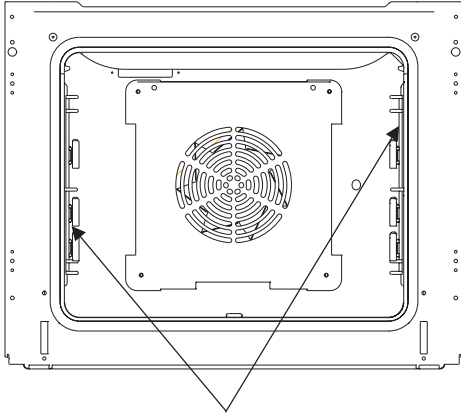

Oven lighting

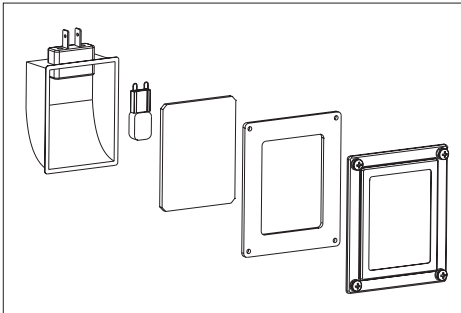

1. Unplug the appliance
2. Remove shelves and trays from the oven.
3. If the oven has telescopic runners, remove them also.
4. Using a cross-head screwdriver remove the four screws holding the lamp cover, remove the cover and the seal, wash clean taking care to wipe the cover dry.
5. Pull the halogen bulb out by sliding it down using a cloth or paper. If necessary, replace the halogen bulb with a new one.
 - voltage 230V
 - power 25W
6. Replace the halogen bulb in its socket.
7. Replace the lamp cover and the seal. Tighten.

Note: Do NOT touch the halogen bulb directly with your fingers!

CLEANING AND MAINTENANCE

Door removal

In order to obtain easier access to the oven chamber for cleaning, it is possible to remove the door. To do this, tilt the safety catch part of the hinge upwards (fig. A). Close the door lightly, lift and pull it out towards you. In order to fit the door back on to the cooker, do the inverse. When fitting, ensure that the notch of the hinge is correctly placed on the protrusion of the hinge holder. After the door is fitted to the oven, the safety catch should be carefully lowered down again. If the safety catch is not set it may cause damage to the hinge when closing the door.

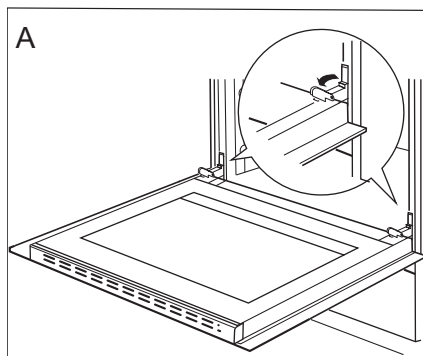

Tilting the hinge safety catches

Removing the inner panel

1. Using a flat screwdriver unhook the upper door slat, prying it gently on the sides (fig. B).
2. Pull the upper door slat loose. (fig. B, C)

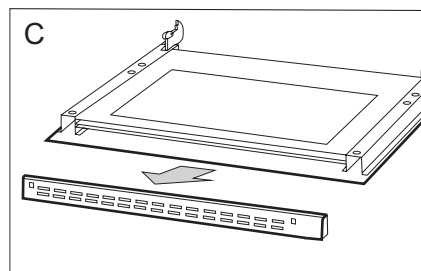
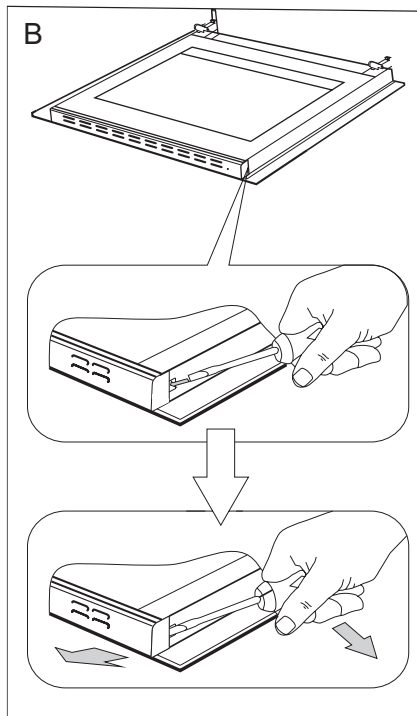

CLEANING AND MAINTENANCE

3. Pull the inner glass panel from its seat (in the lower section of the door). Remove the inner panel (fig. D).
4. Clean the panel with warm water with some cleaning agent added.

Carry out the same in reverse order to reassemble the inner glass panel. Its smooth surface shall be pointed upwards.

Important! Do not force the upper strip in on both sides of the door at the same time. In order to correctly fit the top door strip, first put the left end of the strip on the door and then press the right end in until you hear a “click”. Then press the left end in until you hear a “click”.

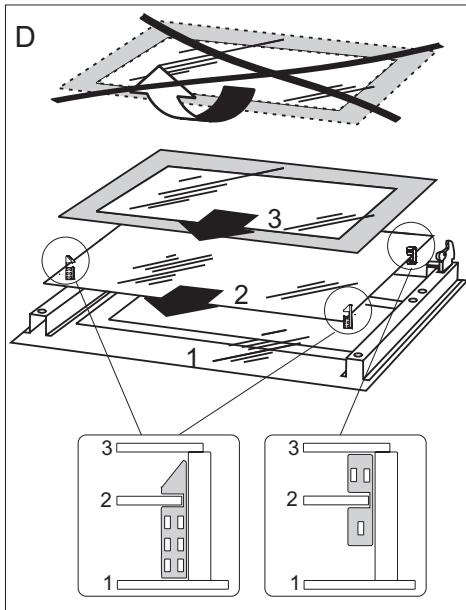

Removal of the internal glass panel

Regular inspections

Besides keeping the oven clean, you should:

- carry out periodic inspections of the control elements and cooking units of the cooker. After the guarantee has expired you should have a technical inspection of the cooker carried out at a service centre at least once every two years,
- fix any operational faults,
- carry out periodical maintenance of the cooking units of the oven.

Caution!

All repairs and regulatory activities should be carried out by the appropriate service centre or by an appropriately authorised fitter.

TROUBLESHOOTING

In the event of any fault:

- turn off the appliance,
- disconnect the power supply,
- based on the instructions given in the table below, some minor issues can be corrected by the user. Please check the consecutive points in the table before you refer the repair to customer service.

Problem	Reason	Remedy
1. The appliance does not work	no power	check the fuse, replace if blown
2. Oven lighting does not work.	loose or damaged bulb	Replace the blown bulb (see <i>Cleaning and Maintenance</i> section)
3. E0 error message on the screen	Temperature sensor failure	See the Operating Instructions chapter: <i>Main Menu \ Settings \ Service</i>
4. E1 error message on the screen	meat probe failure	See the Operating Instructions chapter: <i>Main Menu \ Settings \ Service</i>
5. E2 error message on the screen	Steam generator sensor failure	See the Operating Instructions chapter: <i>Main Menu \ Settings \ Service</i>
6. Touchscreen activates	Induction hob above the oven is being used	Activate Child Lock, see the Operating Instructions chapter: <i>Special functions</i>

TECHNICAL DATA

Voltage rating	230V~50 Hz
Power rating	max. 3,1 kW
Oven dimensions H/W/D	59,5 / 59,5 / 57,5 cm
Complies with EU regulations	EN 60335-1, EN 60335-2-6 standards

Certificate of compliance CE

The Manufacturer hereby declares that this product complies with the general requirements pursuant to the following European Directives:

- *The Low Voltage Directive 2006/95/EC,*
- *Electromagnetic Compatibility Directive 2004/108/EC,*
- *ErP Directive 2009/125/EC,*

*and therefore the product has been marked with the **CE** symbol and the **Declaration of Conformity** has been issued to the manufacturer and is available to the competent authorities regulating the market.*
